

BTF Series

Ultra-slim and amplifier built-in type

NEW

■ Features

- Realization of ultra-slim size by adopting one-chip photo IC
- Size: Through-beam(W13×H19×L3.7mm),
Diffuse reflective, BGS reflective(W13×H24×L3.7mm)
- Adopts BGS method superior than convergent reflective to minimize error by background color, or material of sensing object for stable sensing
- Visible light source to check the position of sensing spot and superior to small sensing target with narrow sensing width
- Built-in reverse polarity, output short, overcurrent protection circuit
- Protection structure IP67(IEC standard)

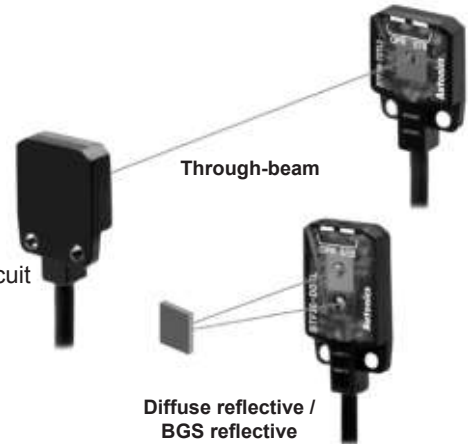

⚠ Please read "Caution for your safety" in operation manual before using.



■ Specifications

Model	NPN open collector output		BTF1M-TDTL		BTF1M-TDTD		BTF30-DDTL		BTF30-DDTD		BTF15-BDTL		BTF15-BDTD	
	PNP open collector output		BTF1M-TDTL-P		BTF1M-TDTD-P		BTF30-DDTL-P		BTF30-DDTD-P		BTF15-BDTL-P		BTF15-BDTD-P	
Sensing type	Through-beam				Diffuse reflective				BGS reflective					
Sensing distance	1m				5 to 30mm (Non-glossy white paper 50×50mm)				1 to 15mm (Non-glossy white paper 50×50mm)					
Sensing target	Opaque materials of max. ϕ 2mm				Opaque materials, Translucent materials									
Min.sensing target	Opaque materials of ϕ 2mm				ϕ 0.2mm (Sensing distance 10mm)				ϕ 0.2mm non-illuminated objects (Sensing distance 10mm)					
Hysteresis	—				Max. 20% at rated sensing distance				Max. 5% at rated sensing distance					
Reflectivity characteristics (black/white error)	—				—				Max. 15% of maximum sensing distance					
Response time	Max. 1ms													
Power supply	12-24VDC \pm 10%(Ripple P-P: Max. 10%)													
Current consumption	Max. 20mA(This is for each emitter and receiver of through-beam type)													
Light source	Red LED(650nm)													
Operation mode	Light ON		Dark ON		Light ON		Dark ON		Light ON		Dark ON			
Control output	NPN or PNP open collector output ●Load voltage: Max. 26.4VDC ●Load current: Max. 50mA ●Residual voltage - NPN:Max. 1V, PNP:Max. 2V													
Protection circuit	Reverse polarity protection, output short-circuit protection													
Indicator	Operation indicator: Red, Stability indicator: Green													
Insulation resistance	Min. 20M Ω (at 500VDC megger)													
Noise resistance	\pm 240V the square wave noise(pulse width:1 μ s) by the noise simulator													
Dielectric strength	1,000VAC 50/60Hz for 1 minute													
Vibration	1.5mm amplitude or 300m/s ² at frequency of 10 to 55Hz(for 1 min.) in each of X, Y, Z directions for 2 hours													
Shock	500m/s ² (approx. 50G) in each of X, Y, Z directions for 3 times													
Environment	Ambient illumination		Sunlight: Max. 10,000lx Incandescent lamp: Max. 3,000lx (Receiver illumination)											
	Ambient temperature		-25 to 55°C, storage: -40 to 70°C											
	Ambient humidity		35 to 85%RH, storage: 35 to 85%RH											
Protection	IP67(IEC standards)													
Material	Case: PBT, Sensing part : PMMA													
Cable	ϕ 2.5, 3-wire, Length: 2m (Emitter of through-beam type: ϕ 2.5, 2-wire, Length: 2m) (AWG28, Core diameter: 0.08mm, Number of cores: 19, Insulator out diameter: ϕ 0.9)													
Accessory	Fixing bracket(SUS304), Bolt(SWCH10A)													
Approval	CE													
Unit weight	Approx. 40g				Approx. 25g									

※The temperature or humidity mentioned in Environment indicates a non freezing or condensation environment.

Ultra-Slim and Amplifier Built-in type

■ Feature data

◎ Through-beam

● BTF1M-TDTL / BTF1M-TDTL-P

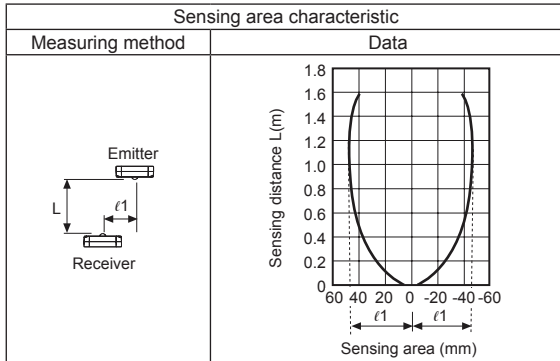

◎ Diffuse reflective

● BTF30-DDTL / BTF30-DDTL-P

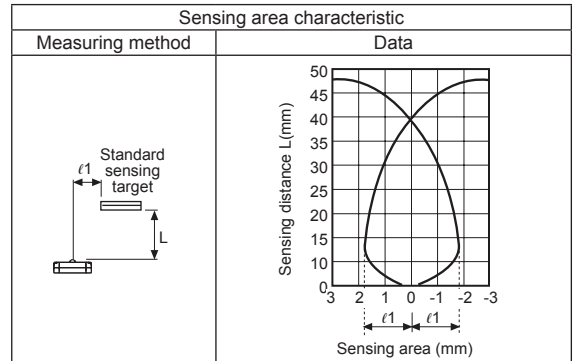

◎ BGS reflective

● BTF15-BDTL / BTF15-BDTL-P

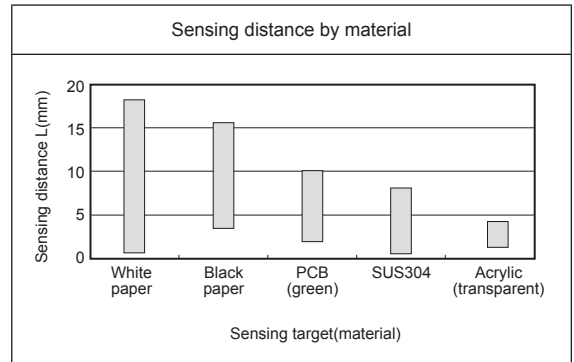
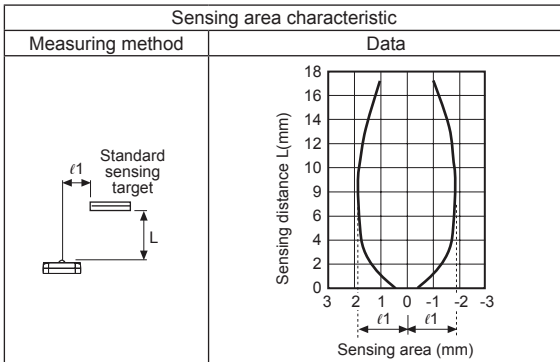

■ Connections

● Through-beam

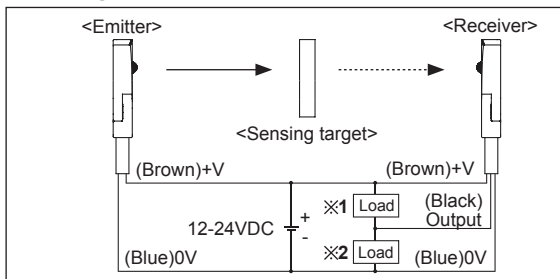

● Diffuse reflective/BGS reflective

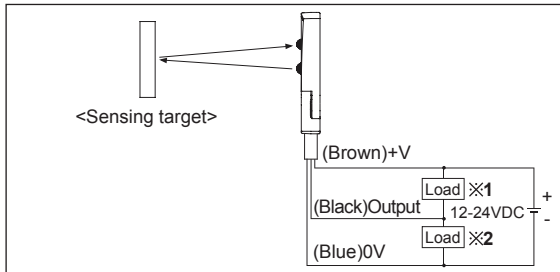

※1: Load connection for NPN output

※2: Load connection for PNP output

■ Control output diagram

● NPN open collector output

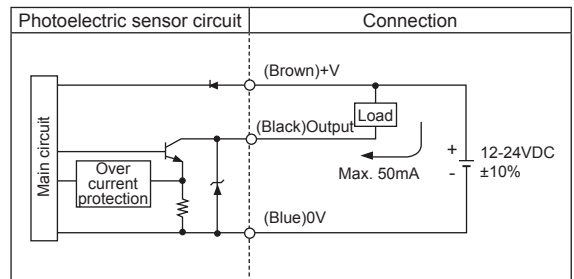

● PNP open collector output

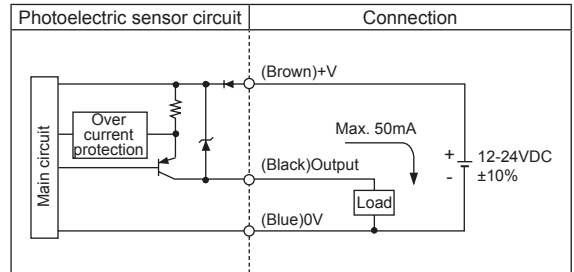

(A) Photo electric sensor

(B) Fiber optic sensor

(C) Door/Area sensor

(D) Proximity sensor

(E) Pressure sensor

(F) Rotary encoder

(G) Connector/Socket

(H) Temp. controller

(I) SSR/ Power controller

(J) Counter

(K) Timer

(L) Panel meter

(M) Tacho/ Speed/ Pulse meter

(N) Display unit

(O) Sensor controller

(P) Switching mode power supply

(Q) Stepper motor & Driver&Controller

(R) Graphic/ Logic panel

(S) Field network device

(T) Software

(U) Other

BTF Series

■ Operation mode

Operation mode	Light ON	Dark ON
Receiver operation	Received light Interrupted light	Received light Interrupted light
Operation indicator (red LED)	ON OFF	ON OFF
Transistor output	ON OFF	ON OFF

■ Dimensions

(unit: mm)

● Through-beam

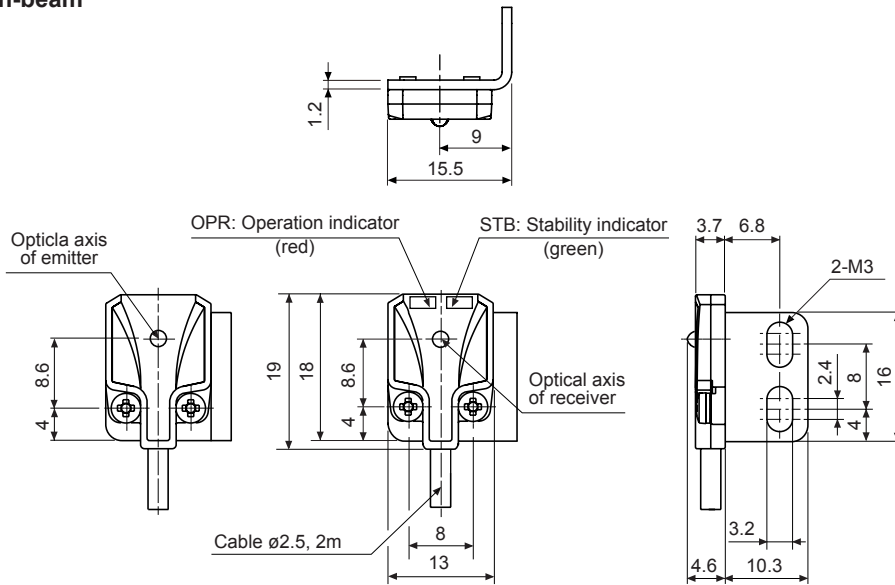

● Diffuse reflective/BGS reflective

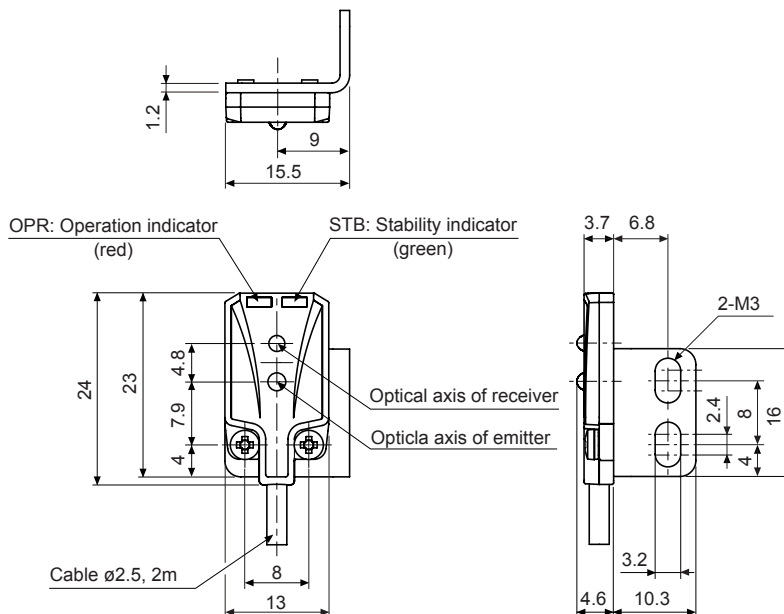

Ultra-Slim and Amplifier Built-in type

■ Operation timing diagram

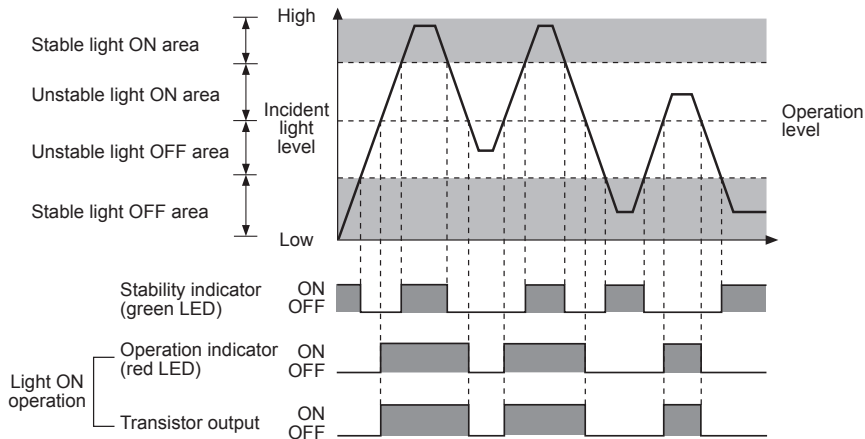

※ The waveforms of "Operation indicator" and "Transistor output" are for Light ON operation. They are opposite operation for Dark ON operation.

■ Mounting and sensitivity adjustment

◎ For mounting

Please use bolts M2 for mounting this sensor and the tightening torque is under 0.3 N·m.

※ Do not impact on the unit with hard objects and do not bend the cable part too much. It may cause damage to waterproof function.

● Through-beam

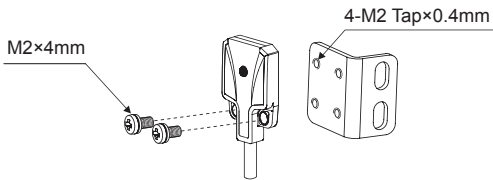

● Diffuse reflective/BGS reflective

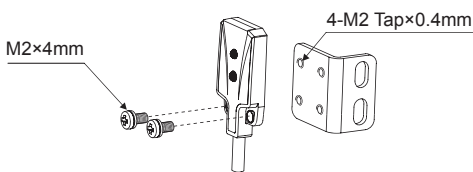

※ Notice for BGS reflective type

1) Make sure that the sensing side of this sensor is parallel with the surface of each sensing object.

2) If the sensing object has glossy surface or high reflection, the sensor tilts to 5 to 10° as shown in the figure. Make sure whether the sensor is influenced by any background objects.

3) Make sure to install the sensor in the proper direction with considering moving direction of sensing objects. Refer to the following.

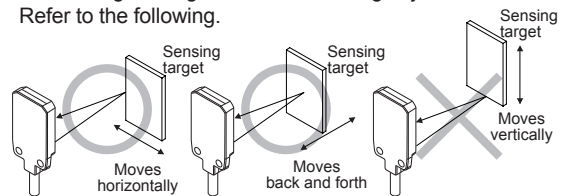

◎ Optical axis adjustment

● Through-beam

Set the emitter and the receiver facing each other and adjust these up-down, right-left after to check the point operating the stability indicator. Fix the emitter and the receiver at the center of the point.

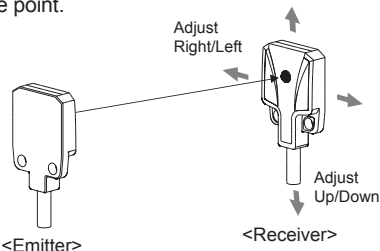

● Diffuse reflective/BGS reflective

After place a sensing target, fix it in the middle of position where the stability indicator operates adjusting the sensor to up-down, right-left. Make sure that the sensing side of the sensor is parallel with the surface of each sensing target.

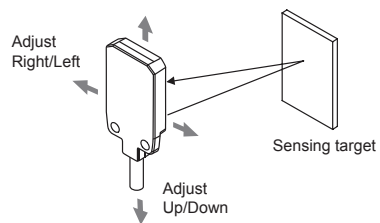

(A) Photo electric sensor

(B) Fiber optic sensor

(C) Door/Area sensor

(D) Proximity sensor

(E) Pressure sensor

(F) Rotary encoder

(G) Connector/Socket

(H) Temp. controller

(I) SSR/Power controller

(J) Counter

(K) Timer

(L) Panel meter

(M) Tacho/Speed/Pulse meter

(N) Display unit

(O) Sensor controller

(P) Switching mode power supply

(Q) Stepper motor& Driver&Controller

(R) Graphic/Logic panel

(S) Field network device

(T) Software

(U) Other